

LOT OCCUPANCY W/OUT STREET AND ALLEY	
LOT AREA:	202,613.60 SF
COVERED AREA:	45,227.49 SF
LOT OCCUPANCY:	22.32 %

LOT OCCUPANCY W/ STREET AND ALLEY	
LOT AREA:	222,541.60 SF
COVERED AREA:	45,227.49 SF
LOT OCCUPANCY:	20.32 %

NOTE: LOT AREA AND LOT OCCUPANCY BASED ON FUTURE REALIGNED KENNEDY

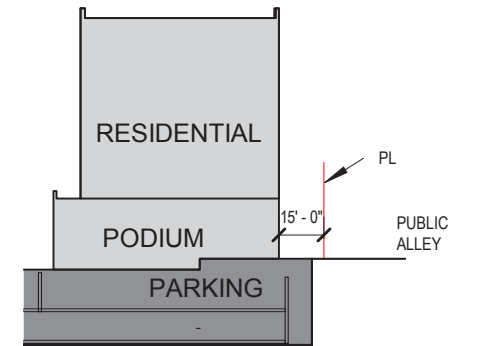
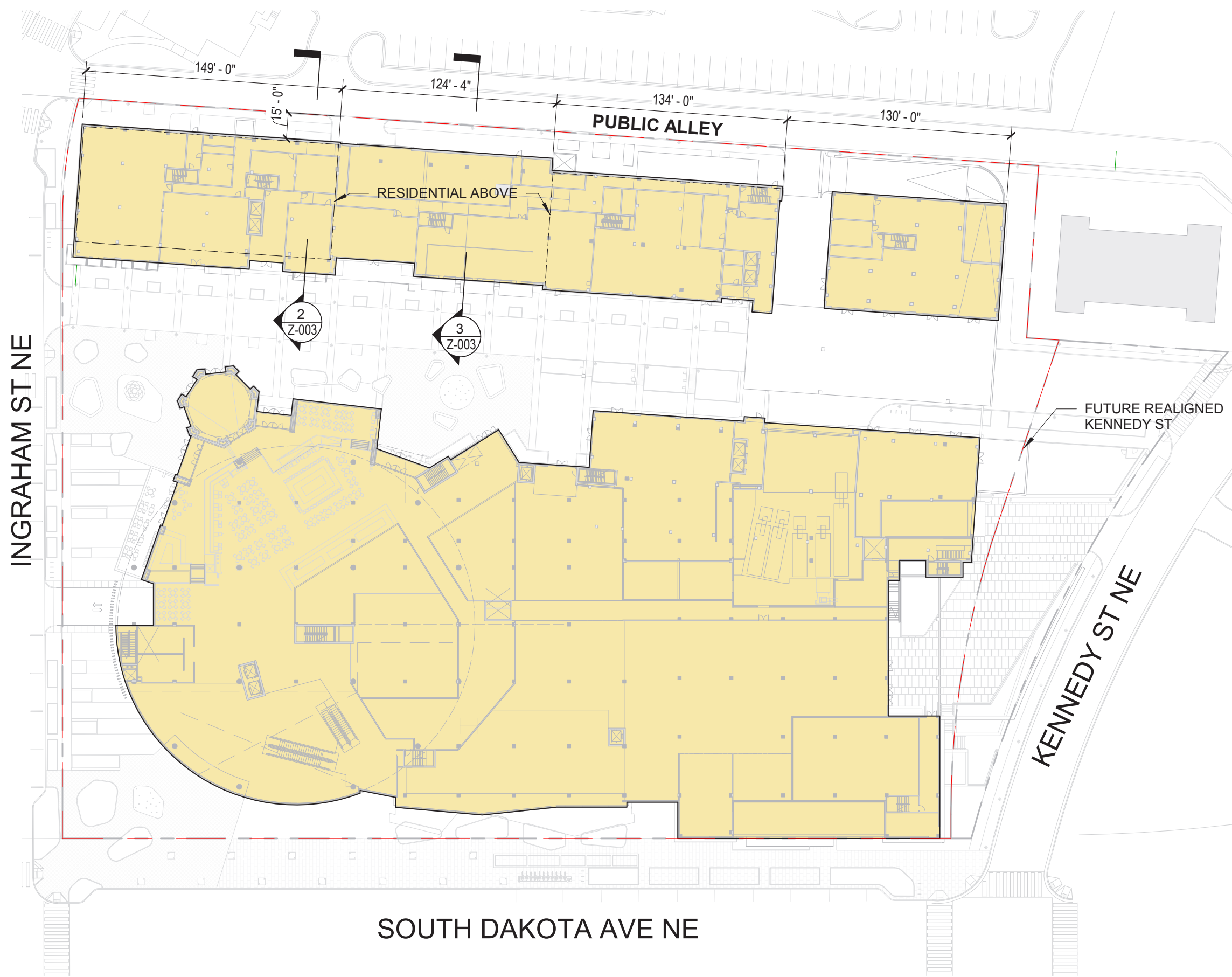

2 REAR YARD SECTION 1
1/64" = 1'-0"

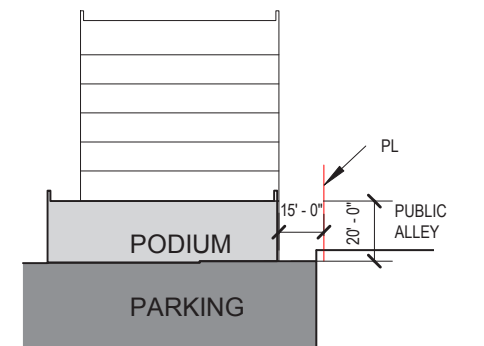

3 REAR YARD SECTION 2
1/64" = 1'-0"

INTENTIONALLY BLANK

ARCHITECTURE EXHIBITS

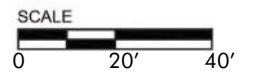
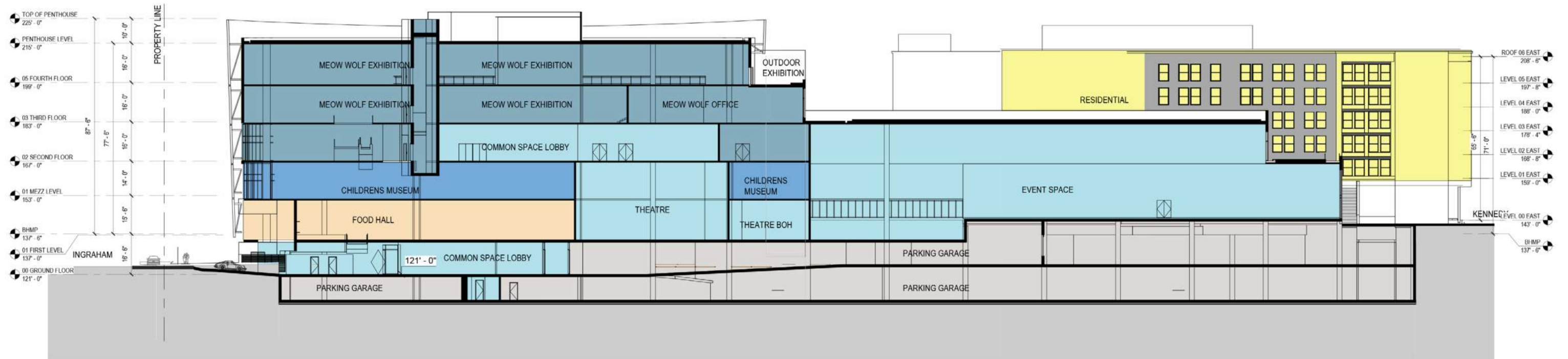
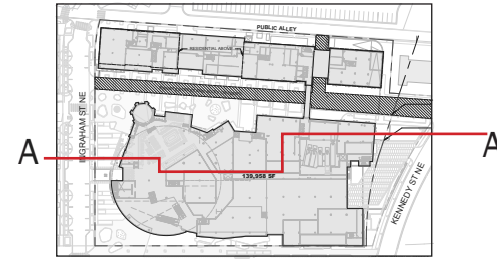

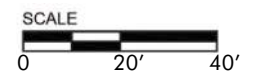
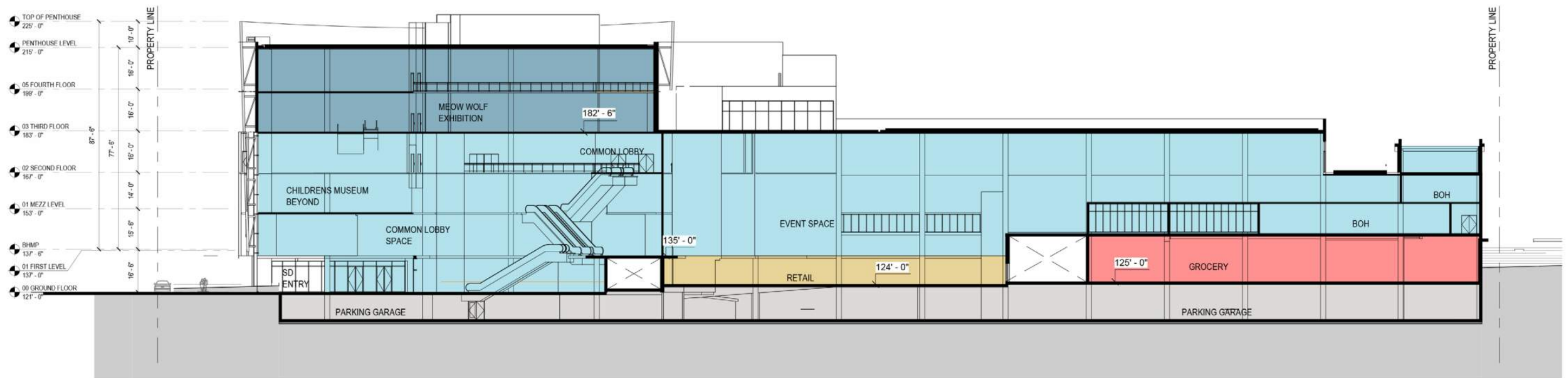
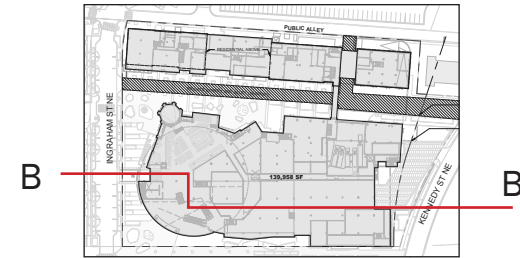

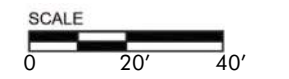
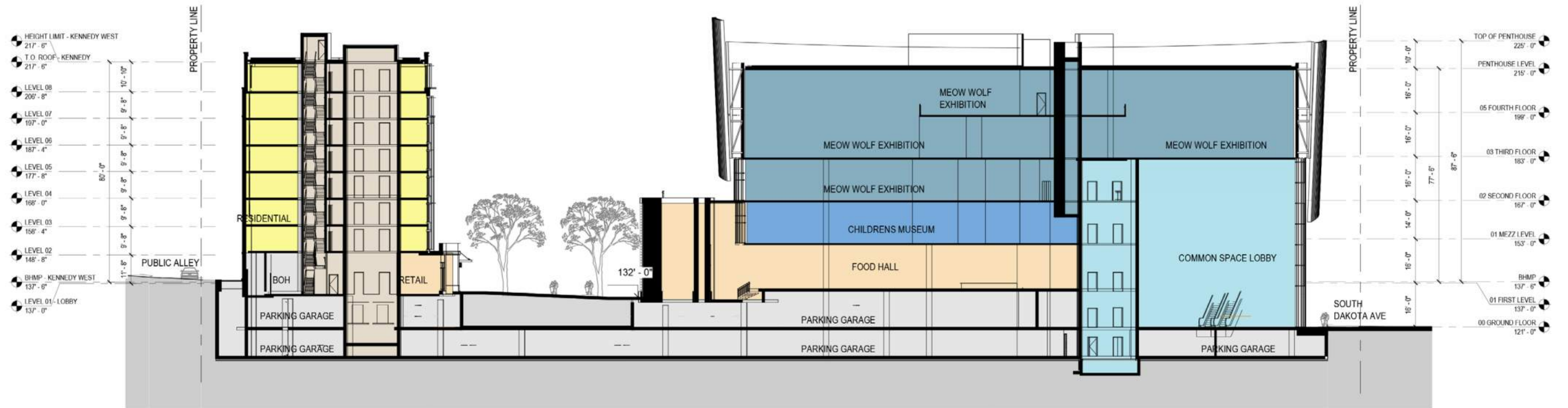
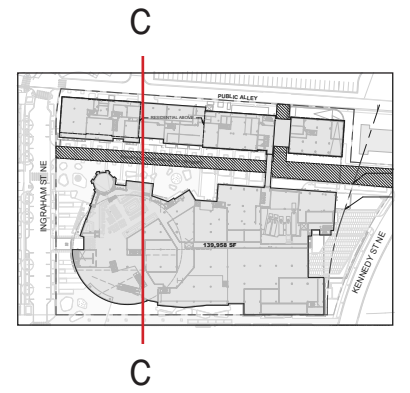

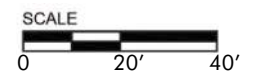
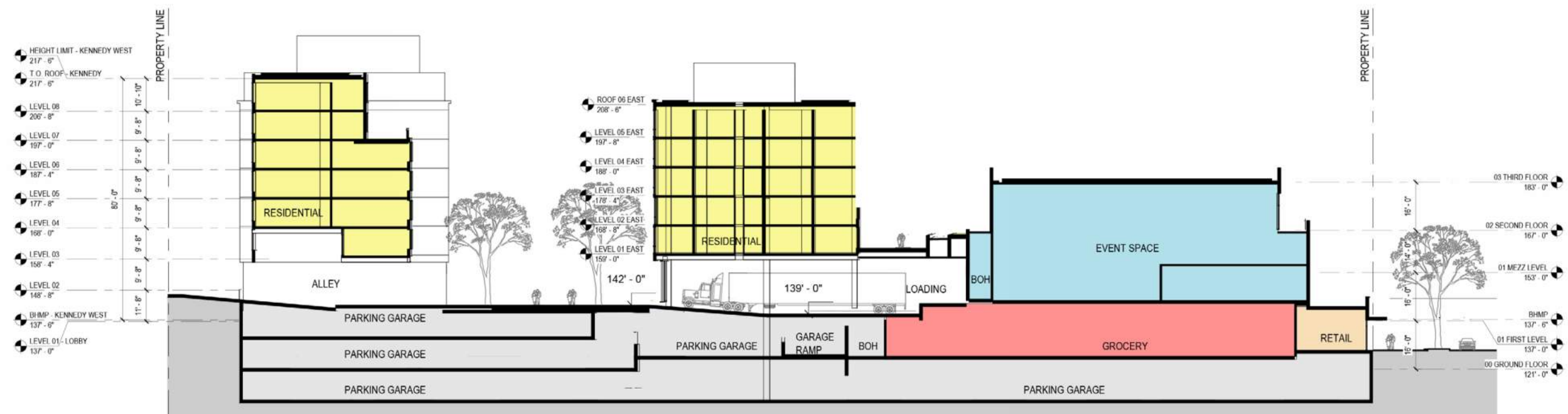

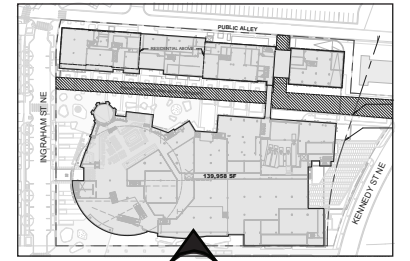

TOP OF PENTHOUSE 225'-0"
 PENTHOUSE LEVEL 215'-0"
 05 FOURTH FLOOR 199'-0"
 03 THIRD FLOOR 183'-0"
 02 SECOND FLOOR 167'-0"
 01 MEZZ LEVEL 153'-0"
 BHMP 137'-6"
 01 FIRST LEVEL 137'-0"
 00 GROUND FLOOR 121'-0"

TOP OF PENTHOUSE 225'-0"
 PENTHOUSE LEVEL 215'-0"
 05 FOURTH FLOOR 199'-0"
 03 THIRD FLOOR 183'-0"
 02 SECOND FLOOR 167'-0"
 01 MEZZ LEVEL 153'-0"
 BHMP 137'-6"
 01 FIRST LEVEL 137'-0"
 00 GROUND FLOOR 121'-0"

